

GP3000H Series Installation Guide

Caution

Be sure to read the "Warning/Caution Information" on the attached sheet before using the product.

Package Contents

- (1) GP Unit (1)
- (2) English and Japanese Installation Guides (one of each) <This Guide>
- (3) Warning/Caution Information (1)
- (4) Hand Strap (1)

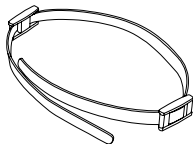

- (5) Touch Pen (1, attached to the GP unit)

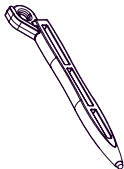

- (6) Hanger (1, attached to the GP unit)
The hanger is used to hang the GP unit on a wall.
- (7) Function Switch Sheet
(5 sets for replacement,
1 set attached to the GP unit)

- (8) Emergency Switch Guard (1)
Attachment Screws (3)^{*1}

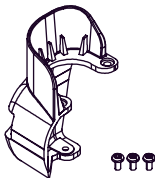

^{*1} Only for the GP unit with the Emergency Switch

- (9) Connector Cover
(1, attached to the GP unit)

This unit has been carefully packed, with special attention to quality. However, should you find anything damaged or missing, please contact your local GP distributor immediately.

About the Manual

For the detailed information on the GP3000H series, refer to the following manual.

- GP3000H Series Hardware Manual
- GP3000H Conversion Adapter Installation Guide
- GP3000H Direct-connect Cable Installation Guide
- Maintenance/Troubleshooting
- GP-Pro EX Reference Manual "Hand Held GP"

The manuals can be selected from the help menu of GP-Pro EX or downloaded from Pro-face Home Page.

URL

<http://www.pro-face.com/otasuke/>

Part Names and Functions

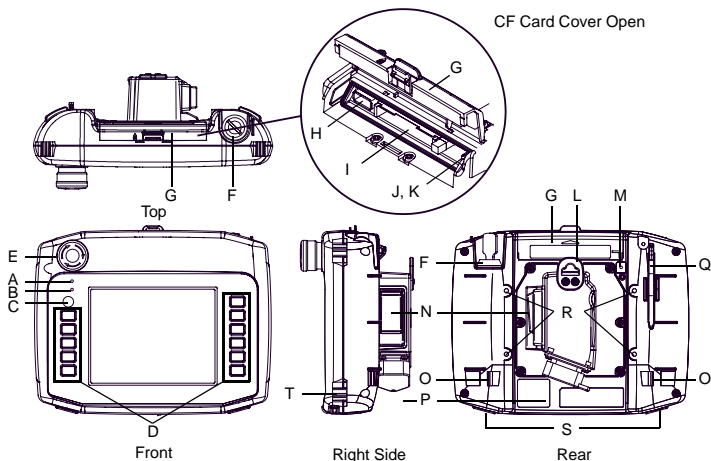

Name		Description																		
A	Status LED (POWER)	This LED indicates the GP's status, e.g. power input, firmware RUN status or backlight condition.																		
		<table border="1"> <thead> <tr> <th>Color</th> <th>Indicator</th> <th>Operation Mode</th> </tr> </thead> <tbody> <tr> <td rowspan="2">Green</td> <td rowspan="2">ON</td> <td>OFFLINE</td> </tr> <tr> <td>In operation</td> </tr> <tr> <td>Red</td> <td>ON</td> <td>When power is turned on.</td> </tr> <tr> <td rowspan="2">Orange</td> <td>ON</td> <td>Backlight burnout</td> </tr> <tr> <td>Flashing</td> <td>During software startup</td> </tr> <tr> <td colspan="2">Not Lit</td> <td>Power is OFF.</td> </tr> </tbody> </table>	Color	Indicator	Operation Mode	Green	ON	OFFLINE	In operation	Red	ON	When power is turned on.	Orange	ON	Backlight burnout	Flashing	During software startup	Not Lit		Power is OFF.
		Color	Indicator	Operation Mode																
		Green	ON	OFFLINE																
				In operation																
Red	ON	When power is turned on.																		
Orange	ON	Backlight burnout																		
	Flashing	During software startup																		
Not Lit		Power is OFF.																		
B	Operation LED (O.P.)	<table border="1"> <thead> <tr> <th>LED</th> <th>GP Status</th> </tr> </thead> <tbody> <tr> <td>Green</td> <td>Indicates the Operation Switch is ON.</td> </tr> <tr> <td>Not Lit</td> <td>Indicates the Operation Switch is OFF.</td> </tr> </tbody> </table>	LED	GP Status	Green	Indicates the Operation Switch is ON.	Not Lit	Indicates the Operation Switch is OFF.												
		LED	GP Status																	
		Green	Indicates the Operation Switch is ON.																	
Not Lit	Indicates the Operation Switch is OFF.																			
C	Operation Switch	When this switch is enabled and pressed, the GP unit can accept input from the touch panel and function keys.																		
D	Function Switches (11 switches)	The switch functions are set up with the screen design software. For details, refer to the GP-Pro EX Reference Manual.																		
E	Emergency Switch	—																		

F	Key Switch	Turning the key turns ON/OFF the GP unit power supply.																									
G	CF Card Cover	<p>The CF Card I/F, USB I/F, DIP Switches and LAN status LED are located in the CF Card Cover open.</p> <p>IMPORTANT</p> <ul style="list-style-type: none"> During operation of the GP unit, keep the CF Card cover closed. If the GP unit is used with this cover open, it will cause a fault of the GP unit. 																									
H	USB Host Interface	<p>Complies with USB 1.1. Uses a "TYPE-A" connector. Power supply voltage: DC5 V±5%, Output current: 500 mA (max). Connect to the transfer cable, storage device (USB memory, CF Card reader), etc. The maximum communication distance: 5 m.</p>																									
I	CF Card Interface	Insert the CF Card in this slot.																									
J	Dip Switches	<div style="text-align: center;">  </div> <table border="1" style="width: 100%; border-collapse: collapse;"> <thead> <tr> <th>Dip Switches</th> <th>Function</th> <th>ON</th> <th>OFF</th> <th>Note</th> </tr> </thead> <tbody> <tr> <td style="text-align: center;">1</td> <td>CF Card Startup Settings (Controls unit startup from the CF Card.)</td> <td>Startup from CF Card is enabled.</td> <td>Startup from CF Card is disabled.</td> <td>CF Card with startup data required.</td> </tr> <tr> <td style="text-align: center;">2*1</td> <td>Forced Transfer Mode</td> <td>Forced Transfer Mode: ON</td> <td>Forced Transfer Mode: OFF</td> <td style="text-align: center;">—</td> </tr> <tr> <td style="text-align: center;">3</td> <td>Booking</td> <td style="text-align: center;">—</td> <td style="text-align: center;">—</td> <td>Constantly OFF</td> </tr> <tr> <td style="text-align: center;">4</td> <td>CF Card access setting</td> <td>CF Card access enabled</td> <td>CF Card access disabled</td> <td style="text-align: center;">—</td> </tr> </tbody> </table> <p>*1 When power supply is turned ON at DIP Switch 2 is ON, it starts with Transfer Mode. Usually, use it in OFF.</p> <p>IMPORTANT</p> <ul style="list-style-type: none"> After inserting a CF Card, be sure to turn ON DIP Switch 4, and close the CF Card cover before using the GP unit. Before removing the CF Card, turn OFF DIP Switch 4 first, and make sure that the CF Card access LED turns off. If you remove the CF Card while the CF Card is being accessed (while the LED is lit), it may result in data corruption. 	Dip Switches	Function	ON	OFF	Note	1	CF Card Startup Settings (Controls unit startup from the CF Card.)	Startup from CF Card is enabled.	Startup from CF Card is disabled.	CF Card with startup data required.	2*1	Forced Transfer Mode	Forced Transfer Mode: ON	Forced Transfer Mode: OFF	—	3	Booking	—	—	Constantly OFF	4	CF Card access setting	CF Card access enabled	CF Card access disabled	—
Dip Switches	Function	ON	OFF	Note																							
1	CF Card Startup Settings (Controls unit startup from the CF Card.)	Startup from CF Card is enabled.	Startup from CF Card is disabled.	CF Card with startup data required.																							
2*1	Forced Transfer Mode	Forced Transfer Mode: ON	Forced Transfer Mode: OFF	—																							
3	Booking	—	—	Constantly OFF																							
4	CF Card access setting	CF Card access enabled	CF Card access disabled	—																							

K	LAN Status LED	<p>The LED turns ON or OFF to indicate the current status of the Ethernet transmission interface (10BASE-T/100BASE-TX).</p> <table border="1" data-bbox="324 142 969 372"> <thead> <tr> <th data-bbox="324 142 508 171">LED</th> <th data-bbox="508 142 969 171">Indicates</th> </tr> </thead> <tbody> <tr> <td data-bbox="324 171 508 205">Green ON</td> <td data-bbox="508 171 969 205">Data transmission available</td> </tr> <tr> <td data-bbox="324 205 508 238">Green Flashing</td> <td data-bbox="508 205 969 238">Data transmission is occurring.</td> </tr> <tr> <td data-bbox="324 238 508 272">Green OFF</td> <td data-bbox="508 238 969 272">No connection or subsequent transmission failure</td> </tr> <tr> <td data-bbox="324 272 508 305">Orange ON</td> <td data-bbox="508 272 969 305">During connection with 100BASE-TX</td> </tr> <tr> <td data-bbox="324 305 508 372">Orange OFF</td> <td data-bbox="508 305 969 372">During connection with 10BASE-T or No connection</td> </tr> </tbody> </table>	LED	Indicates	Green ON	Data transmission available	Green Flashing	Data transmission is occurring.	Green OFF	No connection or subsequent transmission failure	Orange ON	During connection with 100BASE-TX	Orange OFF	During connection with 10BASE-T or No connection
LED	Indicates													
Green ON	Data transmission available													
Green Flashing	Data transmission is occurring.													
Green OFF	No connection or subsequent transmission failure													
Orange ON	During connection with 100BASE-TX													
Orange OFF	During connection with 10BASE-T or No connection													
L	Hanger	<p>A hanger for temporarily hanging the GP unit on a wall.</p> <p>IMPORTANT</p> <ul style="list-style-type: none"> Do not operate or conduct wiring of the GP unit, with the GP unit hung on a wall. The GP may fall, resulting in injury or damage to the equipment. <p>NOTE</p> <ul style="list-style-type: none"> The following is recommended to be used as pairs for this hanger; <ul style="list-style-type: none"> A $\Phi 7$ or less, rod-shaped or S-shaped hook M4 pan-head machine screw, which head diameter is $\Phi 7$ or less. Panel thickness: 1 to 1.6mm [0.04 to 0.06 in.], Panel width: 14mm [0.55 in.] 												
M	CF Card Access LED	<table border="1" data-bbox="324 792 969 947"> <thead> <tr> <th data-bbox="324 792 467 825">Access LED</th> <th data-bbox="467 792 969 825">Indicates</th> </tr> </thead> <tbody> <tr> <td data-bbox="324 825 467 883">Green ON</td> <td data-bbox="467 825 969 883">Indicates that a CF Card is inserted and DIP Switch 4 is set to ON, or that the CF Card is being accessed.</td> </tr> <tr> <td data-bbox="324 883 467 947">Green OFF</td> <td data-bbox="467 883 969 947">Indicates that DIP Switch 4 is set to OFF, or that no CF Card is inserted.</td> </tr> </tbody> </table>	Access LED	Indicates	Green ON	Indicates that a CF Card is inserted and DIP Switch 4 is set to ON, or that the CF Card is being accessed.	Green OFF	Indicates that DIP Switch 4 is set to OFF, or that no CF Card is inserted.						
Access LED	Indicates													
Green ON	Indicates that a CF Card is inserted and DIP Switch 4 is set to ON, or that the CF Card is being accessed.													
Green OFF	Indicates that DIP Switch 4 is set to OFF, or that no CF Card is inserted.													
N	3-Position Enable Switch	<p>The switch provides three positions: A position where the switch is not pressed (released), a position where the switch is pressed to the intermediate position, and a position where the switch is pressed to the innermost position (fully pressed).</p>												
O	Hand Strap Attachment Slots	—												
P	GP3000H Cable Connector (with Connector Cover)	Connects the GP3000H dedicated cable.												
Q	Touch Pen	—												
R	Wall Adapter Attachment Slots	To mount the GP unit to a panel or commercially available arm, attach the GP3000H dedicated wall-hanging adapter (optional) to this slot.												

S	Insertion hole (with cover) for Function Switch Sheet	—
T	Neck Strap Attachment Slot	—

General Specifications

■ Electrical Specifications

Power Supply	Input Voltage	DC24 V
	Rated Voltage	DC19.2 V to 28.8 V
	Allowable Voltage Drop	10 ms (max.)
	Power Consumption	16.7 W (max.)
	In-Rush Current	60 A (max.) Half width (Time duration with a current exceeding 30 A): 40 μ s max.
Voltage Endurance	AC500 V 20 mA for 1 minute (between charging and FG terminals)	
Insulation Resistance	DC500 V 10 M Ω (min.) (between charging and FG terminals)	

■ Environmental Specifications

Physical	Ambient Operating Temperature	0 to 40°C
	Storage Temperature	-20 to +60°C
	Ambient Humidity	10 to 90% RH (Wet bulb temperature: 39°C max. - no condensation.)
	Storage Humidity	10 to 90% RH (Wet bulb temperature: 39°C max. - no condensation.)
	Dust	0.1 mg/m ³ and below (non-conductive levels)
	Pollution Degree	For use in Pollution Degree 2 environment

Connection with Peripheral Equipment (Specifications of the GP3000H Direct Connect Cable)

The following GP3000H direct-connect cable (optional) is required.

Name	Model	Description
GP3000H Hard-type 10m Direct-connect Cable	GP3000H-CBLH-10M	Heavy-duty type interface cable for communication between the GP and external equipment (e.g. host controller), equipped with common mode filter.
GP3000H Soft-type 3m Direct-connect Cable	GP3000H-CBLS-3M	Standard type interface cable for communication between the GP and external equipment (e.g. host controller), equipped with common mode filter.
GP3000H Soft-type 5m Direct-connect Cable	GP3000H-CBLS-5M	
GP3000H Soft-type 10m Direct-connect Cable	GP3000H-CBLS-10M	

NOTE

- To connect the GP3000H conversion adapter, an additional connector cable is required. For details, refer to “GP3000H Conversion Adapter Installation Guide”.

1. Connecting Peripheral Equipment

IMPORTANT

- Do not allow the cable's connector to drop or hit against anything hard, or the connector could be damaged.
- Be sure to connect peripheral equipment first, and connect the GP unit last. Otherwise, the RS232C/RS422/RS485 circuit may fail.
- Be sure to terminate unused wires to avoid short-circuits by other signals or metal parts.
- After cable length adjustment, be sure to connect the shield on the cable to the FG terminal.

Serial Interface

Recommended Cable Connector	XM2D-0901 <made by OMRON Corp.>
Recommended Jack Screw #4-40 (UNC)	XM2Z-0073 <made by OMRON Corp.>
Recommended Cable Cover	XM2S-0913 <made by OMRON Corp.>

Cable Color/ Marking Color, Number	RS232C ^{*1}		RS422/RS485 ^{*1}	
	Signal Name	Description	Signal Name	Description
Brown/White 1	CD	Carrier Detect	RDA	Receive Data A(+)
Brown/Black 1	RD(RXD)	Receive Data	RDB	Receive Data B(-)

Cable Color/ Marking Color, Number	RS232C ^{*1}		RS422/RS485 ^{*1}	
	Signal Name	Description	Signal Name	Description
Brown/White 2	SD(TXD)	Send Data	SDA	Send Data A(+)
Brown/White 4	ER(DTR)	Data Terminal Ready	ERA	Data Terminal Ready A(+)
Brown/None	SG	Signal Ground	SG	Signal Ground
Brown/Black 3	DR(DSR)	Data Set Ready	CSB	Clear to Send B(-)
Brown/Black 2	RS(RTS)	Request to Send	SDB	Send Data B(-)
Brown/White 3	CS(CTS)	Clear to Send	CSA	Clear to Send A(+)
Brown/Black 4	CI(RI)/VCC	Called status display/ +5 V±5% Output 0.25 A ^{*2}	ERB	Data Terminal Ready B(-)
Green/None	FG ^{*3}	Frame Ground (Common with SG)	FG ^{*2}	Frame Ground (Common with SG)

*1 Communication method is switched via software.

*2 The RI/VCC selection is switched via software. The VCC output is not protected against overcurrent. To prevent damage or unit malfunctions, use only the rated current.

*3 Select AWG22 cable to use out of two green cables.

IMPORTANT

- The GP3000H direct connect cable's serial interface is not isolated. When the host (PLC) unit is also not isolated, and to reduce the risk of damaging the RS232C/RS422/RS485 circuit, be sure to connect the SG (Signal Ground) terminal.

NOTE

- If isolation is required, use the Pro-face's RS232C isolation unit (CA3-ISO232-01), and the following recommended equipment.

Recommended Intermediate Connector	XM2A-0901 <made by OMRON Corp.>
Recommended Fastener 1	XM2Z-0003 <made by OMRON Corp.>
Recommended Cable Cover	XM2S-0913 <made by OMRON Corp.>

■ Ethernet Interface

Ethernet (IEEE802.3u, 10BASE-T/100BASE-TX) with modular jack connector (RJ-45)

Cable Color	Signal Name	Direction	Description
Blue	TX +	Output	Ethernet Send (+)
White	TX -	Output	Ethernet Send (-)
Brown	RX +	Input	Ethernet Receive (+)
Gray	RX -	Input	Ethernet Receive (-)

■ DC24 V Interface

⚠ WARNING

- To avoid an electric shock, prior to connecting the GP unit's power cord terminals to the power terminal block, confirm that the GP unit's power supply is completely turned OFF, via a breaker, or similar unit.
- Supplying a power voltage other than that specified will damage the power source and the GP unit.
- Since there is no power switch on the GP unit, be sure to attach a breaker switch to the power cord.
- When the FG terminal is connected, be sure the wire is grounded.

Cable Color	Signal Name	Direction	Description
Red	DC24 V	Input	Power Input DC24 V
Black	0 V	Input	Power Input 0 V
Green	FG ^{*1}	—	Frame Ground (Common with SG)

*1 Select AWG16 cable to use out of two green cables.

NOTE

- Be sure to twist Power Input wires from a part close to the power supply.
- It's recommended to use the provided common mode filter on the direct-connect cable to reduce noise.

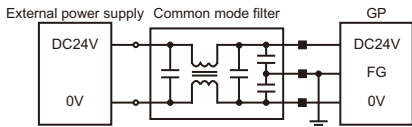

- The black square indicates the connection point for the dedicated cable and common field filter.

The above image is an example internal circuit for a common mode filter. For the actual circuit in use, refer to the specifications of your common mode filter

◆ Power Supply Cautions

- Input and Output signal lines must be separated from the power control cables for operational circuits.
- To improve the noise resistance, be sure to twist the ends of the power cord wires before connecting them to the power supply.
- The GP unit's power supply cord should not be bundled with or kept close to main circuit lines (high voltage, high current), or input/output signal lines.
- To reduce noise, make the power cord as short as possible.
- If the supplied voltage exceeds the GP unit's range, connect a voltage transformer.

- Between the line and the ground, be sure to use a low noise power supply. If there is an excess amount of noise, connect a noise reducing transformer.
- The temperature rating of field installed conductors: 60°C only.
- DC 24V input unit must be used with a Class 2 power supply.

IMPORTANT

- Use voltage and noise reducing transformers with capacities exceeding Power Consumption value.
- Connect a surge absorber to handle power surges.

IMPORTANT

- Be sure to ground the surge absorber (E1) separately from the GP unit (E2). Select a surge absorber that has a maximum circuit voltage greater than that of the peak voltage of the power supply.

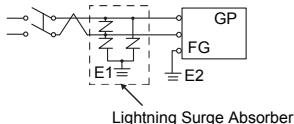

◆ Grounding Cautions

- Be sure to create an exclusive ground for the Power Cord's FG terminal. Use a grounding resistance of 100 Ω, a wire of 2 mm² or thicker, or your country's applicable standard.
- The SG (signal ground) and FG (frame ground) terminals are connected internally in the GP unit. When connecting the SG line to another device, be sure that the design of the system/ connection does not produce a shorting loop.
- The grounding wire should have a cross sectional area greater than 2 mm². Create the connection point as close to the GP unit as possible, and make the wire as short, as possible. When using a long grounding wire, replace the thin wire with a thicker wire, and place it in a duct.

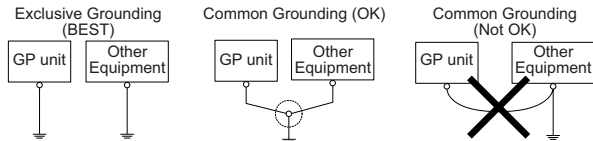

◆ Input/Output Signal Line Cautions

- All GP Input and Output signal lines must be separated from all operating circuit (power) cables.
- If this is not possible, use a shielded cable and ground the shield.

■ 3-Position Enable Switch Output Interface

Cable Color/ Marking Color, Number	Signal Name	Description
Blue/Black 2	ENB0A	3-position enable switch 0A (a-contact:normally open) Rating: DC30V, 700 mA (Minimum applicable load: DC3V, 5mA)
Blue/Black 3	ENB0B	3-position enable switch 0B (a-contact:normally open)
Blue/None	ENB1A	3-position enable switch 1A (a-contact:normally open) Rating: DC30V, 700 mA (Minimum applicable load: DC3V, 5mA)
Blue/Black 1	ENB1B	3-position enable switch 1B (a-contact:normally open)

The switch provides three positions: A position where the switch is not pressed (released), a position where the switch is pressed to the intermediate position, and a position where the switch is pressed to the innermost position (fully pressed).

When the switch is set at each position, ON/OFF status of the ENB0 to ENB1 signals are as follows:

	The switch is not pressed.	The switch is pressed to the intermediate position.	The switch is pressed to the innermost position.*1
ENB0	0 (OFF)	1 (ON)	0 (OFF)
ENB1	0 (OFF)	1 (ON)	0 (OFF)

*1 The contact is OFF when the switch is fully depressed and then returned to the released position.

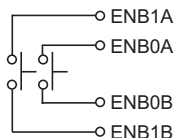

■ Emergency Switch Output Interface

Cable Color/ Marking Color, Number	Signal Name	Description
Purple/Black 2	EMG0A	Emergency switch 0A (a-contact:normally open) Rating: DC30 V, 1 A (Minimum applicable load: DC5 V, 1 mA)
Purple/White 3	EMG0B	Emergency switch 0B (a-contact:normally open)
Purple/Black 1	EMG1A	Emergency switch 1A (b-contact:normally closed) Rating: DC30 V, 1 A (Minimum applicable load: DC5 V, 1 mA)
Purple/White 2	EMG1B	Emergency switch 1B (b-contact:normally closed)
Purple/None	EMG2A	Emergency switch 2A (b-contact:normally closed) Rating: DC30 V, 1 A (Minimum applicable load: DC5 V, 1 mA)
Purple/White 1	EMG2B	Emergency switch 2B (b-contact:normally closed)

For GP units with emergency switches, the enabled emergency switch activates the contact output. To reset the emergency stop status (lock status), pull the button forward, or turn the button in the direction indicated by arrow.

When the emergency switch is pressed, ON/OFF status of the EMG0 to EMG2 signals are as follows:

() indicates contact status.

	Emergency Stop Reset	Emergency Stop
EMG0	0 (OFF)	1 (ON)
EMG1	1 (ON)	0 (OFF)
EMG2	1 (ON)	0 (OFF)

NOTE

- These signal lines must be disconnected (NC) when a GP unit without an emergency switch is used.

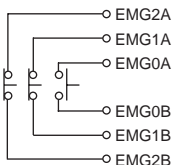

■ Key Switch Output Interface

Cable Color/ Marking Color, Number	Signal Name	Meaning
Orange/None	KEY_NC	Key Switch b-contact (normally closed) Rating: DC24V, 300 mA
Orange/Black 1	KEY_NO	Key Switch a-contact (normally open) Rating: DC24V, 300 mA

- Turning OFF GP unit with the key switch

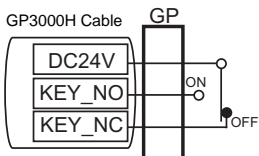

- Turning ON GP unit with the key switch

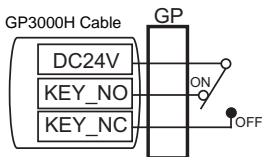

NOTE

- When the key is not turned to ON or OFF, either the “KEY_NO” or the “KEY_NC” signal is ON. These signals will not simultaneously turn OFF.
- These signal lines must be disconnected (NC) when a GP unit without a key switch is used.

2. Connecting the GP Unit

◆ Attachment

- (1) Before connection, remove the cable's connector cap and GP3000H connector cover.
To remove the cable's connector cap, pull out the cable by holding the cable connector as shown.

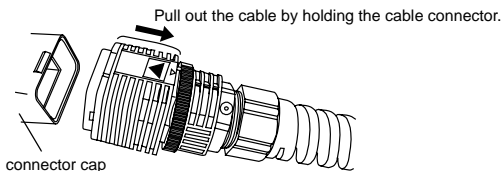

NOTE

- To disconnect this cable from the connector cap, be sure to hold the cable connector and pull it out. If you hold other parts of this cable (lock ring, etc.), the cable cannot be disconnected.
- (2) Insert the cable connector to the GP3000H cable connector until it clicks. Match the ▲ points and insert the cable connector, as shown below.

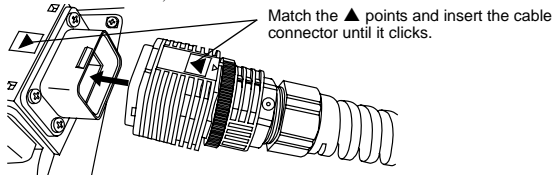

NOTE

- Be sure to insert the cable connector as shown. Failure to do so might result in damage to the connector.

- (3) Turn the cable connector lock ring to lock the connector, so that the small \triangle mark (for LOCK) on the lock ring is aligned with the small ∇ mark on the cable connector.

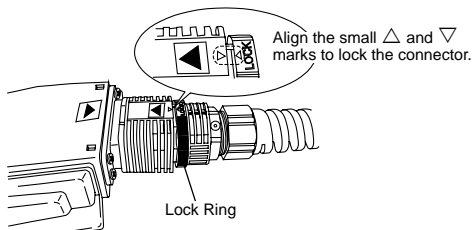

◆ Removal

- (1) Unlock the connector that has been locked in the mounting procedure. (Turn the lock ring as shown so that the small \triangle mark is displaced from the ∇ mark). Then, pull out the cable by holding the cable connector.

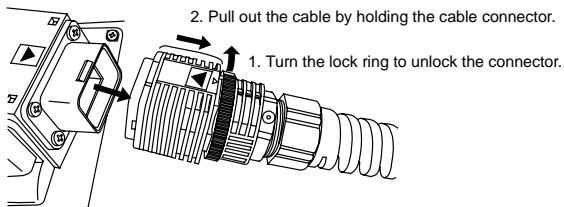

NOTE

- To disconnect the cable, be sure to hold the cable connector and pull it out. If you hold other parts of the cable (lock ring, etc.), the cable cannot be disconnected.

Attaching the Hand Strap

Attach the hand strap to the GP unit, and hold the strap so that GP unit will not fall.

- (1) Insert the hand strap into the hand strap mounting slots on the GP unit rear panel, as shown below.

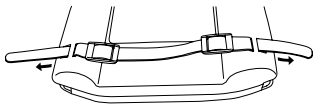

- (2) Insert both ends of the hand strap into the buckles as shown below, and fasten them securely.

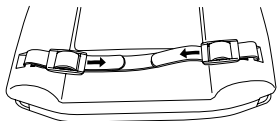

Attaching the Emergency Switch Guard

WARNING

- When the emergency switch guard is attached, the emergency switch is not conformable to safety standards (EC Machinery Directive IEC60204-1, etc.). If conforming to the safety standards is required, do not use the emergency switch guard (included in the GP unit).

- (1) Prepare three screws for mounting the emergency switch guard (included in the packages of GP units with the emergency switch built in).



- (2) Remove the emergency switch guard hole covers at two places beside the emergency switch.

Emergency Switch
Guard Hole Covers

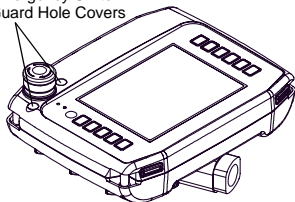

- (3) Align the three screw holes of the emergency switch guard with the screw holes of the GP unit, and fasten the two points in the front, and the one point in the rear of the GP unit with screws.

First, align the screw holes of the emergency switch guard with those of the GP unit.

Fasten the two points in the front, and the one point in the rear of the GP unit with screws.

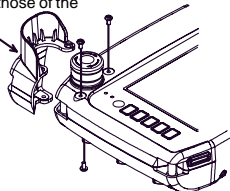

IMPORTANT

- Tightening each screw with excessive torque may result in damage to the equipment. Appropriate tightening torque is 0.5 N·m.
- (4) The following is the complete mounting configuration:

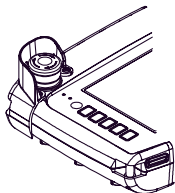

UL/c-UL Approval

The following units are UL/c-UL listed products*1: (UL File No.E220851)

Product Model No.	UL/c-UL Registration Model No.
AGP3300H-L1-D24	3610005-03
AGP3300H-S1-D24	3610005-02
AGP3310H-T1-D24	3610005-01

These products conform to the following standards:

- UL508
Industrial Control Equipment
- CSA-C22.2 No.142-M1987
(c-UL Approval)
Industrial Control Equipment

<Cautions>

Be aware of the following items when building the GP into an end-use product:

- The GP unit must be used indoors only.

*1 The system constructing the following three components conform to UL/c-UL standards:

- GP3000H
- GP3000H Direct-connect Cable (with connector)
GP3000H-CBLHD-10M, GP3000H-CBLSD-3M, GP3000H-CBLSD-5M, GP3000H-CBLSD-10M
- GP3000H Conversion Adapter
AGP3000H-ADPCOM-01

CE Marking

The following units are CE marking products complying with the EMC Directive. These units also conform to EN55011 Class A, EN61000-6-2 directives.

AGP3300H-L1-D24

AGP3300H-S1-D24

AGP3310H-T1-D24

Inquiry

Do you have any questions or comments about this product?
Please access our site anytime if you need help with a solution.

<http://www.pro-face.com/otasuke/>

Note

Please be aware that Digital Electronics Corporation shall not be held liable by the user for any damages, losses, or third party claims arising from the use of this product.



SCIGATE AUTOMATION (S) PTE LTD

No.1 Bukit Batok Street 22 #01-01 Singapore 659592

Tel: (65) 6561 0488

Fax: (65) 6562 0588

Email: sales@scigate.com.sg

Web: www.scigate.com.sg

Business Hours: Monday - Friday 8.30am - 6.15pm

Digital Electronics Corporation
Schneider Electric Osaka Building,
4-4-9 Kitahama, Chuo-ku, Osaka 541-0041
JAPAN
<http://www.pro-face.com/>

Copyright © 2014.5 Digital Electronics Corporation.
All Rights Reserved.
PFX102688G .AGP3300H-MT01E-BTH JM/I